

# Ultra-HD Optical Zoom PTZ

PTZ 4K-NDI-X30

User Manual

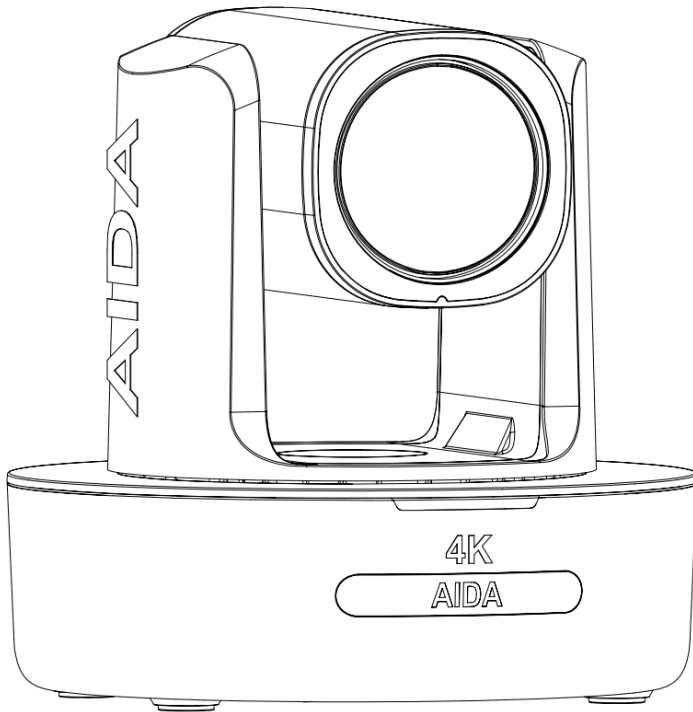

V1.0

**AIDA**

# Table of Contents

1	Safety Guides
2	Packing List & Quick Start
4	Product Highlights & Camera Specs
6	Camera Interface & Dimension
7	IR Remote Controller
9	OSD Menu
12	Web Settings
18	VISCA Over IP
19	VISCA (RS-232) Port
20	VISCA Protocol
29	UVC Control
30	Warranty & Support

*The information within this manual is subject to change at any time without prior notice\**

*NDI® is a registered trademark of Newtek Inc.\**

# Safety Guide

1. Before operation, please read all the instructions in the manual carefully. For your convenience, please keep this manual.
2. The camera power input range is 100-240 VACv(50-60hz.) Ensure the power supply input is within this rate before powering it on.
3. Camera power voltage = 12VDC, rated currency=2A. We suggest you use it with the original power supply supplied in the packaging.
4. Please keep the power cable, video cable, and control cable in a dry, safe place out of any obstructions.
5. Operational environment for the camera should be: 0°C-50°C/32°F-122°F, with humidity levels less than 90%. To avoid any damage, do not place or pour anything on inside or on top of the camera.
6. Avoid placing any extra weight, stress, vibration or pressure on the camera during transportation, storage, or operation.
7. Do not remove the camera housing or cover. Any attempt to self-repair or open the camera will void all warranty.
8. Make sure the camera is on a fixed and balanced platform. Avoid any uneven surfaces.
9. Do no direct the camera towards strong / intensive light. Doing so could cause irreversible damage to the camera sensor, thus voiding all warranty on the camera.
10. Use a dry cloth to clean the camera housing, along with a neutral cleaning agent if necessary. To avoid damage on the camera lens, do not use strong or abrasive cleaning agents on the camera.
11. To avoid mechanical trouble, please do not hands to rotate the camera head. Please refrain from touching or moving the camera while its in motion, as it can cause irreversible damage to the motor mechanisms and thus voiding all warranty on the camera.

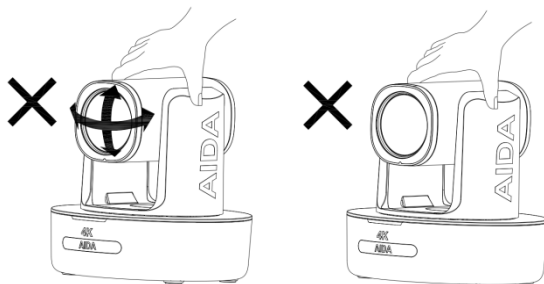

Power Supply Polarity Schematics:

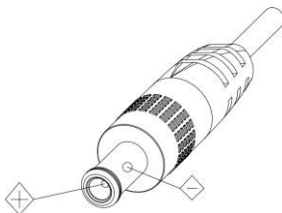

## **⚠ Warning:**

Video quality can be affected by specific frequencies of electromagnetic fields.

# Packing List

Check for the items below when opening the package!

**1**  
EA

- AIDA PTZ Camera
- Power Adapter
- Power Cable
- RS232 Control Cable
- USB Type-C Cable
- Remote Control
- User Manual
- Double Sided Adhesive
- QC Certification
- Wall Mount

## Quick Start

1. Please ensure all the cabling is correct. (PTZ Outputs may vary per model, please check the back of the camera to see which outputs you have.)

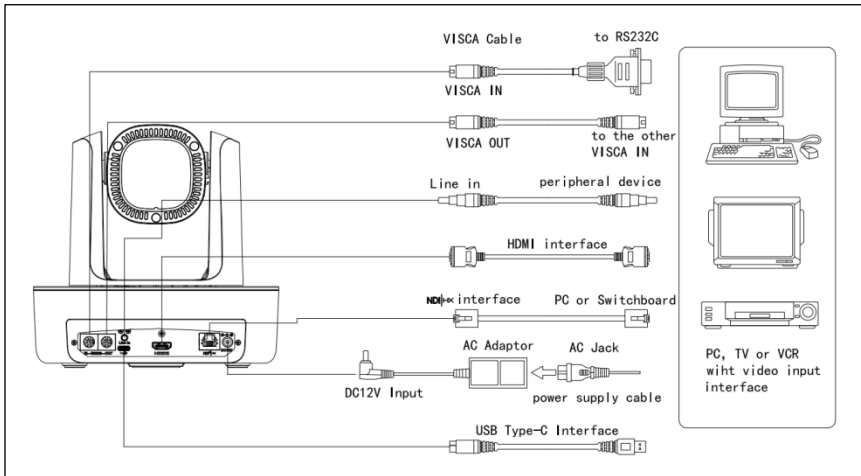

# Quick Start (CONTD)

## For AIDA Support Representatives only:

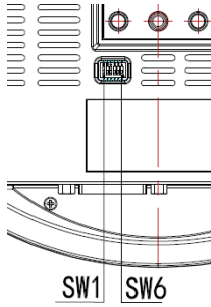

Dial Switch (ARM)			
	SW-1	SW-2	Mode
1	OFF	OFF	Updating Mode
2	ON	OFF	Debugging Mode
3	OFF	ON	Undefined
4	ON	ON	Working Mode

Dial Switch			
	SW-3	SW-4	Instruction
1	OFF	OFF	Reserve
2	ON	OFF	Reserve
3	OFF	ON	Reserve
4	ON	ON	Reserve

Dial Switch (USB)			
	SW-5	SW-6	Instruction
1	OFF	OFF	Undefined
2	ON	OFF	Working Mode
3	OFF	ON	Undefined
4	ON	ON	Undefined

## Product Highlights

- Contains a Sony Progressive CMOS Sensor providing 3840x2160 crisp UHD resolution at up to 60 frames.
- Wide angle optical lens: 30x optical zoom.
- UHD video over IP, via H.264 or H.265 encoding.
- Contains traditional outputs such as HDMI, and RJ-45 for RTSP/RTMP/SRT/NDI® | HX streaming.
- Supports 4K USB streaming (Only if IP / NDI streams are disabled).
- Supports line-in function for unbalanced 3.5mm audio.
- Supports simultaneous outputs via HDMI, and RJ45..
- In-depth fully adjustable camera settings, such as exposure settings, image parameters, and white balance.
- Supports PoE+ (P≤ 25.5W) which allows for single ethernet cable for control and video over a single cable.
- Fast and precise focusing for no-delay video-quality
- Smooth and quiet PTZ movements for sound-sensitive rooms
- Supports up to 10 presets via the remote, or 128 presets via RS232 / web UI.
- Supports Sony Serial Visca and VISCA over IP. Also supports NDI control.
- Supports in and out Serial Daisy Chaining for up to 7 PTZ cameras.
- Menu based parameters such as image flip and mirror for stress-free installations.
- Handheld remote can also be used to switch video formats fast, as well as change camera IP via the menu.
- Free firmware updates to keep the camera up to date with the latest and greatest!
- Supports NDI® | HX transmission.

## Camera Specs

Video Formats (Varies per model)	HDMI	3840*2160P60/59.94/50/30/29.97/25 1920*1080P60/59.94/50/30/29.97/25/24/23.98 1920*1080i60/59.94/50 1280*720P60/59.94/50/30/29.97/25
	USB Type-C	MJPEG, H.264: 3840*2160P30; 1920*1080P30; 1280*720P30; 1024*576P30; 800*448P30 NV12: 1920*1080P10; 1280*720P25; 1024*576P30; 800*448P30
	RJ-45 (NDI®   HX)	3840*2160P15~60; 1920*1080P15~60; 1280*720P15~60; 1024*576P15~60; 640*360P15~30

## Camera Specs (CONTD)

Video Interface	HDMI, RJ-45(NDI®  HX), USB Type-C
Sensor	SONY Progressive CMOS Sensor
Zoom	30x Optical Zoom
Lens	Field of view per lens: 60°(wide)~2°(Tele)(Subject at 20ft from camera) Focal Length and Fstop no.: $f=6.91(\text{near})\sim 214.64\text{mm}(\text{far}), F1.35(\text{Wide})\sim 4.6 (\text{Tele})$
Rotation Angle	Pan: -170°~+170°; Tilt: -30°~+90°
Rotation Speed	Pan: 0°~80°/s; Tilt: 0°~60°/s
Preset	Remote Controller: 10 RS-232: 128
Control Port	RS-232, RJ-45 (NDI®  HX)
Network Speed	1000M
Video Encode	H.264/H.265 (default: H.264)
Bit Rate Control	Variable Bit Rate, Constant Bit Rate
Video Bit Rate	1024kbps(min)~61440 kbps(max)
IP Protocol	RTSP, RTMP, ONVIF, VISCA over IP, NDI®  HX
Line in	Supporting ACC audio coding
Daisy Chain	Support RS-232 serial daisy chain
Minimum Lux	0.01 Lux
White Balance	Auto/Manual/Indoor/Outdoor/One Push/Color Temperature
Exposure	Auto/Manual/Bright/Shutter/Iris
Focus	Auto/Manual
Iris	Auto/Manual
Anti-Flicker	OFF/50Hz/60Hz
Image Voltage	DC12V/PoE+(P≤25.5W)
Dimension	220mm×190mm×193.5mm/8.66"x7.48"x7.62"
Net Weight	1.9kg/4.2lbs

# Camera Interface

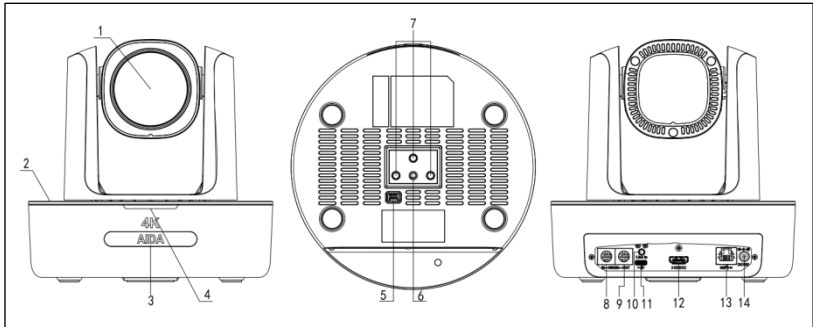

- |                                    |                           |                          |
|------------------------------------|---------------------------|--------------------------|
| 1.Camera Lens                      | 6.¼” tripod mounting hole | 11.USB Type-C            |
| 2.Camera Base                      | 7.WM Installation Holes   | 12.HDMI Output           |
| 3.IR receiver panel                | 8.RS-232 Control Input    | 13.RJ-45(NDI®   HX) Port |
| 4.Power/Tally Indicator            | 9.RS-232 Control Output   | 14.DC12V Plug-in port    |
| 5.Dial Switches(AIDA support only) | 10.Line in port           |                          |

# Camera Dimensions (in mm)

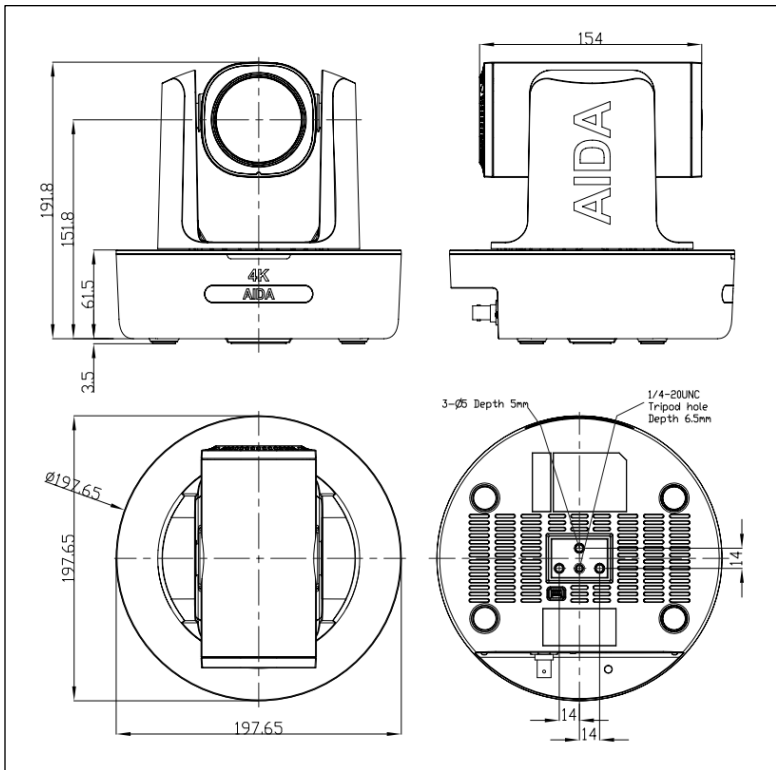



# IR Remote Controller

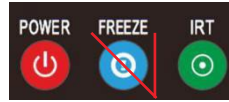

## Power

When powered on, pressing the power key will enter the camera into Standby mode. Pressing it again will start up the camera. \*Note: This is not any means of shutting off the camera, it only shuts down the motor mechanics. Video will still display.

## Freeze (No Function)

The freeze button has no functionality.

## IRT (IR Transfer/IR Pass)

Enables IR Transferring onto 4 separate signals. Best used when operating multiple PTZ's in same line of sight.



## SET 1~4 Address Setting:

Hold the SET# button to set the cameras IR address.

## CAM 1~4 Buttons:

Pressing the CAM# button will enable the IR control of the selected IR Address.

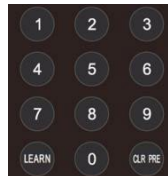

## Number Keys (0-9)

Setting Presets: To set a preset, hold down a key (0-9) and wait 3 seconds. Once complete, the preset will be saved to that #.

Recalling Presets: Pressing a key (0-9) will recall the corresponding preset saved to that number.

## Clearing Presets (CLR PRE)

Clearing Presets: To clear a preset, press CLR PRE and the #.

## Learn (LEARN)

Currently has no independent function. Used with other funcs.

# IR Remote Controller (CONT'D)



## Focus Adjustments (+/-)

Tapping the + or – will set the camera to manual focus for a set precise focus adjustment.

## Zoom Control (+/-)

Tapping the + or – will zoom in or out the camera head.

## Camera head Control (Up/Down/Left/Right)

Tapping the directional buttons will adjust the PTZ head accordingly. If menu is open, these can be used to navigate it.

## Resetting the Camera Head (OK)

Pressing the OK button will reset the PTZ head to HOME. IF menu is open, this can be used to enter sub-menus.

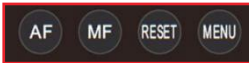

## Auto Focus (AF)

When enabled, the camera will automatically focus on the object in the center of the camera.

## Manual Focus (MF)

When enabled, the camera will remain the same unless adjusted by the +/- focus keys.

## Resetting Image Settings (RESET)

Press to reset all image parameters.

## Accessing the Camera's Menu (MENU)

Press Menu to enter the camera settings.



## Limiting Camera Movement (LIMIT L/R/CLR)

You can adjust the pan / tilt threshold by pressing the LIMIT L and LEARN button to set the Left (LIMIT L) or Right (LIMIT R) threshold. You can use LIMIT CLR to reset this.

## (SCAN)

Currently has no function.



## Video Format Keys (Blue buttons at the bottom)

Allows for hot swapping specific resolutions when needed. Simply hold the blue button corresponding to the resolution you want and it will change. (Only works on HDMI/SDI outputs only.)

(CONTD)

## OSD MENU

1. To enter the menu, simply use the handheld remote and press the MENU key to enter the menu.
2. To navigate the menu, please use the directional keypad.
3. Press the RIGHT directional keypad to enter a submenu. Press the LEFT directional keypad or MENU button to exit a submenu or main menu.

SYSTEM	PROTOCOL	Optional: VISCA, PLC.P, PLC.D	Default: VISCA
	ADDRESS	VISCA:: 1~7 PLC-P/D: 0~255	Default: 1
	BAUDRATE	Optional : 2400, 4800, 9600, 115200	Default: 9600
	PROTOCOL LOCK	Optional : OFF, ON	Default: OFF
	RS485	Optional : OFF, ON	Default: ON
	VISCA PATH	Optional : OVER ALL, OVER IP, OVER COM	Default: OVER ALL
	LANGUAGE	Optional : CHINESE, ENGLISH, RUSSIAN	Default: ENGLISH

EXPOSURE	EXPOSURE MODE	AUTO、MANUAL、SHUTTER、IRIS、BRIGHT	Default: AUTO
	SHUTTER	Shutter speed: 1/30~1/10000, only valid under MANUAL and SHUTTER mode	Default: AUTO
	IRIS	Iris setting: CLOSE~F1.8, only valid under MANUAL and IRIS mode	Default: AUTO
	GAIN	Gain setting: 0dB~30dB, only valid under MANUAL mode	Default: AUTO
	EXPOSURE BRIGHT	Bright setting: 0~27, only valid under BRIGHT priority mode.	Default: AUTO
	BRIGHT	0~15	Default: 8
	BLC	OFF/ON	Default: OFF

IMAGE	WHITE BALANCE MODE	Optional: ATW, MANUAL, AUTO, INDOOR, OUTDOOR, PUSH, C.T.	Default: ATW
	RED GAIN	Red gain level: 0~255, only valid under manual white balance mode	Default: AUTO
	BLUE GAIN	Blue gain level:0~255 , only valid under manual white balance mode	Default: AUTO
	COLOR TEMPERATURE	Set the color temperature value: 2500~10000 only valid under C.T. mode.	Default: AUTO
	FLICKER	Anti-Flicker setting:50/60HZ/OFF, to reduce the video flicker	Default: 50HZ
	FOCUS MODE	AUTO, MANUAL	Default: AUTO

(CONTD)

**OSD MENU**<sub>(CONTD)</sub>

QUALITY	2D NOISE REDUCTION	2D noise reduction: the bigger value is, the less noise on image is, the lower resolution is	Default: OFF
	3D NOISE REDUCTION	3D noise reduction: OFF/AUTO/0~4, the bigger value is, the less motion noise on image is. High value will cause image smear.	Default: AUTO
	SHARPNESS	Sharpness setting: 0~15, the higher value is, edge of the image will be sharpen	Default: 6
	CONTRAST	Set contrast level: 0~15	Default: 8
	SATURATION	Set saturation level: 0~15	Default: 8
	GAMMA	Select gamma level: 0~15	Default: 8

QUALITY	2D NOISE REDUCTION	2D noise reduction: the bigger value is, the less noise on image is, the lower resolution is	Default: OFF
	3D NOISE REDUCTION	3D noise reduction: OFF/AUTO/0~4, the bigger value is, the less motion noise on image is. High value will cause image smear.	Default: AUTO
	SHARPNESS	Sharpness setting: 0~15, the higher value is, edge of the image will be sharpen	Default: 6
	CONTRAST	Set contrast level: 0~15	Default: 8
	SATURATION	Set saturation level: 0~15	Default: 8
	GAMMA	Select gamma level: 0~15	Default: 8

PTZ SETTINGS	SPEED BY ZOOM	Optional: OFF, ON	Default: ON
	FLIP	Flip horizontal	Default: OFF
	MIRROR	Flip vertical	Default: OFF
	PT SPEED	Set Pan Tilt speed: 5~24	Default: 18
	ZOOM SPEED	Set Zoom speed: 1~7	Default: 5
	PRE FRZ FREEZE	Shielding	Default: OFF
	PRESET PT SPEED	Preset head speed:2~24	Default: 15
	PRESET ZOOM SPEED	Preset zoom speed:1~7	Default: 5
	PRESET SAVE AE&AW	Optional: OFF, ON	Default: OFF

VIDEO FORMAT	SIZE	2160P, 1080P, 1080I, 720P
	FRAME RATE	60, 59.94, 50, 30, 29.97, 25, 24, 23.98

IP SETTINGS	DHCP	OFF/ON
	IP	192.168.001.188 (Example)

(CONTD)

## OSD MENU<sub>(CONTD)</sub>

	MASK	255.255.255.000 (Example)
	GATEWAY	192.168.001.001 (Example)
	MAIN SIZE	Current main stream resolution
	BITRATE	Current main stream bit rate
	SUB SIZE	Current sub stream resolution
	BITRATE	Current sub stream bit rate

RESET	SYSTEM RESET	Reset communication parameter to default
	CAMERA RESET	Reset image parameter to default
	PAN TILI RESET	Reset pan/tilt parameter to default
	ALL RESET	Reset all parameter to default

INFO RMATIONS	IR ADDRESS	Camera IR control address
	CLIENT	VISCA
	MODEL NO.	Model number
	ARM VERSION	ARM firmware version
	ISP VERSION	Camera ISP firmware version
	RELEASE DATE	Software release date

# Web Settings

The camera's web UI can be accessed via Google Chrome, Firefox, IE, Safari, Opera, or any other major internet browsers.

## 1. Logging in:

Open your browser and in the address bar, type in the Camera's IP address:

Default IP: 192.168.1.188. If changed, enter that specific IP address.

Default Username: admin

Default Password: admin

\*If you are having trouble logging in, please contact AIDA Imaging support.

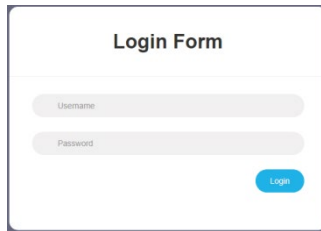

## 2. Real-time Previewing:

When logging in, you will get a real time image preview of the camera via our HTTP protocol.

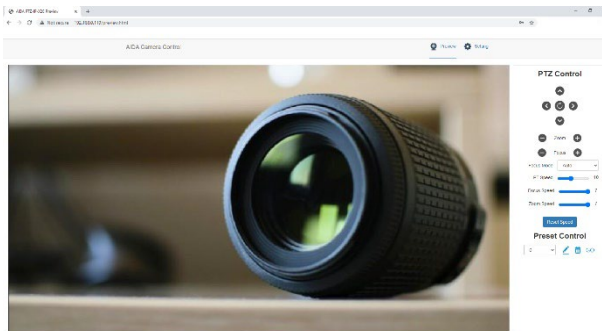

On the right is the control interface. You can control the camera's movements with the directional buttons, as well as adjust the zoom and focus of the camera via the corresponding +/- buttons. Feel free to adjust the speed at which the camera focuses and adjusts via the slider bars as well. You will also find the Preset control to create or recall presets via the web UI.

Near the bottom of the preview is a main and substream player, as well as the option to do a picture in picture preview for adjustable movement of the preview.

# Web Settings (CONT'D)

## Settings:

Clicking the “Settings” button at the top right will enter the cameras web UI settings.

## Video Encode:

Under Video Encode, you will have access to adjust the main and sub video parameters of the camera. This will also adjust the quality of your RTSP, RTMP, SRT and NDI® (if applicable.)

Stream	Main	Sub
Enable	<input checked="" type="checkbox"/>	<input checked="" type="checkbox"/>
Encode Mode	<input type="text" value="H.264"/>	<input type="text" value="H.264"/>
Profile	<input type="text" value="MP"/>	<input type="text" value="MP"/>
RTSP Address	rtsp://192.168.2.188:554/stream/main	rtsp://192.168.2.188:554/stream/sub
Resolution	<input type="text" value="1920x1080"/>	<input type="text" value="1280x720"/>
Bitrate(kbps) (1024-16384)	<input type="text" value="4096"/>	<input type="text" value="2048"/>
Framerate	<input type="text" value="30"/>	<input type="text" value="30"/>
Bitrate Control	<input type="text" value="CBR"/>	<input type="text" value="CBR"/>
I Frame Interval (3-120)	<input type="text" value="30"/>	<input type="text" value="30"/>

## Option Descriptions:

**Encode Mode:** Allows for H.264 or H.265 for better compression streaming (Will not work for NDI and SRT)

**Profile:** Set the encoding profile mode for the camera.

MP: Main Profile – Used for web streaming.

Baseline: Baseline Profile – Used for streaming to legacy devices.

HP: High Profile – Use for recording purposes with other softwares.

**Resolution:** Set the resolution of the stream.

**Bitrate:** Set the bitrate of the camera via (kbps) Higher bitrate = better performance, but can lag a slower system. Lower bitrate = stable performance, but at a loss of quality.

**Framerate:** Change your streams framerate.

**Bitrate Control:** Choose between CBR or VBR. (CBR Recommended for stable streams)

**I-Frame Interval:** Adjust the time inbetween key-frames. Doubling your current framerate is recommended.

# Web Settings (CONTD)

## Video Transmission Settings:

Under video transmission, you will find the options to adjust your RTMP, SRT, or NDI® streams.

## RTMP Setting:

RTMP can be used to stream directly to social media sites such as Youtube, Vimeo, and Facebook Live. To utilize this, please follow the following steps:

1. For better results, please ensure your PTZ is in DHCP mode and connected to the internet.
2. Next obtain the live RTMP address from your website. It should look something like the (?) found on the page.
3. Place the live RTMP address in the RTMP address slot.
4. Next, ensure there is a forward slash after the RTMP address. (/)
5. Lastly, paste the stream key if necessary.
6. Click Save.

RTMP Setting

Stream Main Sub

Enable

RTMP Address

Save

## NDI Setting®:

Here you can adjust your cameras NDI settings. (if applicable to your camera)

NDI

Enable

Name

Groups

Discovery Server

Save

## Option Descriptions:

Name: Change the name that shows up on NDI Studio monitor for manageable multi-cam setups.

Groups: Adjust the NDI group it is categorized in. (Default: public)

Discovery Server: For multiple subnets, set a dedicated NDI PC that hosts a discovery service to connect to, regardless of where you are on the router chain. Enter the NDI PC's IP below.



# Web Settings (CONTD)

## SRT Settings:

In this menu, you can setup a SRT stream to any given software / SRT player.

**SRT Setting** Save

Mode: Listen

Enable:

Port:

Encryption:

Key Length: 32

Passphrase:

Main Stream:

Sub Stream:

Save

## Option Descriptions:

Mode: Change the SRT mode into Listener or Caller.

Port: Enter the SRT port number here.

Encryption: Allows for an encrypted SRT stream.

Key Length: If Encryption is selected, choose the keylength of the password.

Passphrase: Enter the encryption password for the software to connect to the camera.

Main Stream / Sub Stream: Will populate once complete.

Caller mode will look different than this. To get a better idea on how to setup a SRT stream, head to our Youtube at [youtube.com/aidaimaging](https://youtube.com/aidaimaging) for tutorials!

## Audio Settings:

In the "audio settings" tab, audio can be turned off or on. You are also able to adjust the encode mode, samplerate, and bitrate.

**Audio Setting** Save

Audio State:

EncMode: AAC

samplerate: 44100

bitrate: 96000

Save

# Web Settings (CONTD)

## Image Parameters Settings:

In this menu, you can adjust the same parameters found from the OSD menu. All settings will save over the OSD settings.

### Image Parameter



Focus   Exposure   White-Balance   Image   **Image Setting**   Noise-reduction

Focus Mode    ▾

Digital Zoom  

[Reset](#)

## Ethernet Settings:

In this menu, you can adjust ethernet settings of the camera. Below are the standard settings found on the camera by default. Please power cycle the camera after clicking “save.”

DHCP	OFF	DNS	192.168.1.1
IP Address	192.168.1.188	HTTP Port	80
Netmask	255.255.255.0	RTSP Port	554
Gateway	192.168.1.1	VISCA over IP	52381

Use the RTSP Encrypt option to encrypt your RTSP streams.

## Reset to Default:

In this menu, you can reset some of the cameras settings.

**Reset Simply:** Reset ONLY image parameters. IP Settings will remain the same.

**Reset Completely:** Factory reset the whole camera – will default IP address.

**Reboot:** Does not reset anything, simply just restarts the camera.

### Reset to default

[Reset simply](#)

To reset the image parameter

[Reset completely](#)

To reset all parameter and reboot the device

[Reboot](#)

# Web Settings (CONTD)

## Account Settings:

In the account settings, you can change the account name and password from the default. If you lose your new account / password, you will have to contact AIDA support for help, so don't forget to write it down!

### Account Setting

Account	<input type="text"/>
Password	<input type="password"/>
Confirm Password	<input type="password"/>

Ok

## System Time:

In the system time tab, you can adjust the timezone of each clock to sync them.

### System Time Settings

Time Zone	<input type="text" value="UTC"/>
NTP Enable	<input type="checkbox"/>
NTP Update Interval	<input type="text" value="1h"/>
NTP Server Address	<input type="text" value="us.pool.ntp.org"/>
NTP Port	<input type="text" value="80"/>

Save

# VISCA Over IP

## VISCA over IP:

Our PTZ's use VISCA over IP to reliably send and receive information from any standard VISCA over IP controller!

Information of Communications port:

Control Port: RJ-45 LAN connection

IP Protocol: IPv4

Transmission Protocol: UDP

IP Address: \*depends on your camera's IP

Port Address: 52381

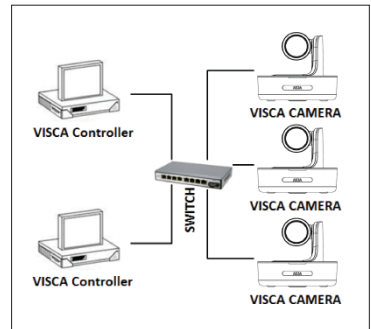

## What is VISCA over IP?

Simply put, VISCA over IP is the magic behind the communications between controller and PTZ cameras! These VISCA commands are sent via UDP protocol. Since UDP transmission isn't stable, a couple of steps must occur before a movement is executed. First, the controller will send out a VISCA command to our camera. Our camera will then receive and send back the same command to the controller. Once the commands are confirmed – the movement will be executed. At the end, a message back to the controller will confirm the action was actually done. Each VISCA command controls its own settings, as there could be no overlaps of existing commands. Luckily, this happens instantaneously so there is no lag when using VISCA over IP!

# VISCA (RS-232) Port

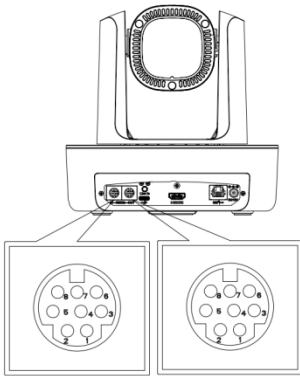

1	DTR
2	DSR
3	TXD
4	GND
5	RXD
6	A
7	IR OUT
8	B

## VISCA IN & Mini DIN Connection

Camera VISCA IN		Mini DIN	
1	DTR	1	DSR
2	DSR	2	DTR
3	TXD	5	RXD
4	GND	4	GND
5	RXD	3	TXD
6	A(+)	6	NC
7	IR OUT	7	NC
8	B(-)	8	NC

## VISCA IN & DB9 Connection

Camera VISCA IN		Windows DB9	
1	DTR	6	DSR
2	DSR	4	DTR
3	TXD	2	RXD
4	GND	5	GND
5	RXD	3	TXD
6	A(+)		
7	IR OUT		
8	B(-)		

## Serial Port Configuration

Parameter	Value	Parameter	Value
Baud Rate	2400/4800/9600/115200	Stop Bit	1 Bit
Start Bit	1 Bit	Check Bit	None
Date Bit	8 Bit		

# VISCA Protocol

For whole updated list, please reach out to our support team!

## Part 1: Camera Return Command

ACK/Completion Message		
	Command Packet	Note
ACK	z0 41 FF	Returned when the command is accepted
Completion	z0 51 FF	Returned when the command has been executed

z= camera address +8

Error Messages		
	Command Packet	Note
Syntax Error	z0 60 02 FF	Returned when the command format is different or when a command with illegal command parameters is accepted
Command Not Executable	z0 61 41 FF	Returned when the command cannot be executed due to current conditions. For example, when commands controlling the focus manually are received during auto focus.

## Part 2: Camera Control Command

AddressSet	Broadcast	88 30 01 FF	Address setting
IF_Clear	Broadcast	88 01 00 01 FF	I/F Clear
CommandCancel		8x 21 FF	
CAM_Power	On	8x 01 04 00 02 FF	Power ON/OFF
	Off	8x 01 04 00 03 FF	
CAM_Zoom	Stop	8x 01 04 07 00 FF	p=0(low)~7(high)
	Tele(Standard)	8x 01 04 07 02 FF	
	Wide(Standard)	8x 01 04 07 03 FF	
	Tele(Variable)	8x 01 04 07 2p FF	
	Wide(Variable)	8x 01 04 07 3p FF	pqrs: Zoom Position (0 (wide)~0x4000(tele))
	Direct	8x 01 04 47 0p 0q 0r 0s FF	
	Direct with speed	8x 0A 04 47 0t 0p 0q 0r 0s FF	t: spd 0~7 pqrs: Zoom Position (0(wide)~0x4000(tele))
	Separate Mode	81 01 04 36 01 FF	Separate with optical zoom control

# VISCA Protocol (CONTD)

CAM_DZoom	Stop	81 01 04 06 00 FF	Enable in separate mode
	Tele(Variable)	81 01 04 06 2p FF	Enable in separate mode
	Wide(Variable)	81 01 04 06 3p FF	Enable in separate mode
	Direct	81 01 04 46 0p 0q 0r 0s FF	Enable in separate mode
CAM_Focus	Stop	8x 01 04 08 00 FF	
	Far(Standard)	8x 01 04 08 02 FF	
	Near(Standard)	8x 01 04 08 03 FF	
	Far(Variable)	81 01 04 08 2p FF	p=0 (Low) to 7 (High)
	Near (Variable)	81 01 04 08 3p FF	p=0 (Low) to 7 (High)
	Direct	8x 01 04 48 0p 0q 0r 0s FF	pqrs: Focus Position
	Auto Focus	81 01 04 38 02 FF	
	Manual Focus	81 01 04 38 03 FF	
	One Push AF	8x 01 04 18 01 FF	
CAM_ZoomFocus	Direct	8x 01 04 47 0p 0q 0r 0s 0t 0u 0v 0w FF	pqrs: Zoom Position (0(wide)~0x4000(tele)) tuvw: Focus Position
CAM_WB	Auto	8x 01 04 35 00 FF	
	Indoor	8x 01 04 35 01 FF	
	Outdoor	8x 01 04 35 02 FF	
	One Push	8x 01 04 35 03 FF	
	ATW	8x 01 04 35 04 FF	
	Manual	8x 01 04 35 05 FF	
	Sodium lamp	8x 01 04 35 08 FF	
	Flourescent	8x 01 04 35 09 FF	
	One Push Trigger	8x 01 04 10 05 FF	
CAM_RGain	Reset	8x 01 04 03 00 FF	
	Up	8x 01 04 03 02 FF	Manual Control of RGain
	Down	8x 01 04 03 03 FF	
	Direct	8x 01 04 43 00 00 0p 0q FF	pq: RGain (0~0xFF)
CAM_BGain	Reset	8x 01 04 04 00 FF	
	Up	8x 01 04 04 02 FF	Manual Control of BGain
	Down	8x 01 04 04 03 FF	
	Direct	8x 01 04 44 00 00 0p 0q FF	pq: BGain (0~0xFF)

# VISCA Protocol (CONTD)

CAM_AE	Full Auto	81 01 04 39 00 FF	Automatic Exposure mode
	Manual	81 01 04 39 03 FF	Manual Control mode
	Shutter Priority	81 01 04 39 0A FF	Shutter Priority Automatic Exposure mode
	Iris Priority	81 01 04 39 0B FF	Iris Priority Automatic Exposure mode
	Bright	81 01 04 39 0D FF	Bright Mode (Manual control)
CAM_Shutter	Reset	8x 01 04 0A 00 FF	Shutter Setting
	Up	8x 01 04 0A 02 FF	
	Down	8x 01 04 0A 03 FF	
	Direct	8x 01 04 4A 00 00 0p 0q FF	pq: Shutter Position (0~0x15)
CAM_Iris	Reset	8x 01 04 0B 00 FF	Iris Setting (0~0x0D)
	Up	8x 01 04 0B 02 FF	
	Down	8x 01 04 0B 03 FF	
	Direct	8x 01 04 4B 00 00 0p 0q FF	pq: Iris Position (0~0x0D)
CAM_Gain	Reset	8x 01 04 0C 00 FF	Gain Setting (0~0x0E)
	Up	8x 01 04 0C 02 FF	
	Down	8x 01 04 0C 03 FF	
	Direct	8x 01 04 0C 00 00 0p 0q FF	pq: Gain Position (0~0x0E)
CAM_Bright	Reset	8x 01 04 0D 00 FF	Bright Setting
	Up	8x 01 04 0D 02 FF	
	Down	8x 01 04 0D 03 FF	
	Direct	8x 01 04 4D 00 00 0p 0q FF	pq: Bright Position (0~0x1B)
CAM_ImageBright	Direct	8x 01 04 A4 00 00 0p 0q FF	pq: Image Bright Position (0~0x0F) AE_AUTO/AE_SHUTTER/AE_IRIS
CAM_WDR	On	8x 01 04 3D 02 FF	Exposure Compensation ON/OFF
	Off	8x 01 04 3D 03 FF	
	Direct	8x 01 04 D3 pq FF	pq: ExpComp Position (0~0x6)
CAM_Backlight (BLC)	On	8x 01 04 33 02 FF	Backlight On
	Off	8x 01 04 33 03 FF	Backlight Off
CAM_Sharpness	Reset	8x 01 04 02 00 FF	Aperture Control
	Up	8x 01 04 02 02 FF	
	Down	8x 01 04 02 03 FF	
	Direct	8x 01 04 42 00 00 0p 0q FF	pq: Aperture Gain (0~0x0F)



# VISCA Protocol (CONTD)

CAM_Memory (preset)	Reset	8x 01 04 3F 00 0p FF	p: Preset Number (=0 to 128) Corresponds to 0-9 on the remote controller
	Set	8x 01 04 3F 01 0p FF	
	Recall	8x 01 04 3F 02 0p FF	
CAM_LR_Reverse	On	8x 01 04 61 02 FF	Image Flip Horizontal On/Off
	Off	8x 01 04 61 03 FF	
CAM_PictureFlip	On	8x 01 04 66 02 FF	Image Flip Horizontal On/Off
	Off	8x 01 04 66 03 FF	
CAM_RS485Ctl	On	8x 01 06 A5 02 FF	
	Off	8x 01 06 A5 03 FF	
CAM_Saturation	Saturation	8x 01 04 A1 00 00 0p 0q FF	pp: Saturation Level 0x00~0xff
CAM_Contrast	Contrast	8x 01 04 A2 00 00 0p 0q FF	pp: Contrast Level 0x00~0xff
CAM_SpeedByZoom	On	8x 01 06 A0 02 FF	
	Off	8x 01 06 A0 03 FF	
CAM_PTSpeed	PT Speed	8x 01 04 C1 00 00 0p 0q FF	pp: PT Speed 0x05~0x18
CAM_ZoomSpeed	Zoom Speed	8x 01 04 D1 00 00 0p 0q FF	pp: Zoom Speed 0x01~0x07
CAM_ZoomDisplay	On	8x 01 06 C2 02 FF	
	Off	8x 01 06 C2 03 FF	
CAM_Freeze	Freeze	8x 01 04 75 0p FF	p: Freeze switch 3=OFF, 2=ON
CAM_Preset Freeze Set	Preset Freeze Set	8x 01 04 76 0p FF	p: Preset Freeze switch 3=OFF, 2=ON
CAM_Preset PT Speed Set	Preset PT Speed Set	8x 01 7E 01 0B 00 qq FF	qq:Preset PT Speed 02~24 default:15
CAM_Preset Zoom Speed Set	Preset Zoom Speed Set	81 01 7E 01 2B 00 qq FF	qq:Preset Zoom Speed 01~07 default:5
CAM_Preset Speed Adj	Preset Speed Adj	8x 01 7E 01 1B 0p FF	p: Adjustment of direction 3=down, 2=up
CAM_IRaddress	IR address	8x 01 06 D8 0p FF	p: IR address1~4
CAM_Gamma	Gamma set	81 01 04 5B 0p FF	p: Gamma No. (0~4)
CAM_ColorGain	Direct	8x 01 04 49 00 00 0p 0p FF	(0~0x0E)
CAM_2DNR	Direct	8x 01 04 A5 0p FF	(0~0x1)
CAM_3DNR	Direct	8x 01 04 53 0p FF	(0~0x05)
FLICK	50Hz	81 01 04 23 01 FF	
	60Hz	81 01 04 23 02 FF	
	OFF	81 01 04 23 00 FF	

# VISCA Protocol (CONTD)

VideoSystem Set (AIDA)		8x 01 06 35 00 pp FF	pp: 1080P60 1080P50 1080i60 1080i50 1080P30 1080P25 720P60 720P50 720P30 720P25 1080P5994 1080i5994 1080P2997 720P5994 720P2997 1080P24 1080P2398 4K@30 4K@25 Video Format: 0x00 0x01 0x02 0x03 0x 04 0x05 0x 06 0x07 0x08 0x09 0x0E 0x0F 0x10 0x13 0x14 0x11 0x12 0x15 0x16
VideoSystem Set (Sony)		81 01 04 24 72 0p 0q FF	pp: 1080P60 1080P50 1080i60 1080i50 1080P30 1080P25 720P60 720P50 720P30 720P25 1080P5994 1080i5994 1080P2997 720P5994 720P2997 1080P24 1080P2398 4K@30 4K@25 Video Format: 0x2e 0x2f 0x01 0x04 0x06 0x08 0x09 0x0c 0x0e 0x11 0x13 0x02 0x07 0x0a 0x0f 0x2a 0x2b 0x1D 0x1E
CAM_IDWrite		8x 01 04 22 0p 0q 0r 0s FF	pqrs: Camera ID (=0000 to FFFF)
DHCP control	DHCP off	8x 01 04 AE 00 FF	DHCP off
	DHCP on	8x 01 04 AE 01 FF	DHCP on
Main Stream	Resolution	8x 01 04 C2 00 0p 0q 0r 0s 0m 0n 0x 0y FF	pqrs: Column(x size) mnx; Line (y size) only support: 1920x1080/1280x720
	Rate	8x 01 04 C2 01 0p 0q 0r 0s 0m 0n 0x 0y FF	pqrsmnxy: bitrate (1024~16384)
Sub Stream	Resolution	8x 01 04 C3 00 0p 0q 0r 0s 0m 0n 0x 0y FF	pqrs : Column(x size) mnx; Line (y size) only support: 1280x720/1024x576/640x360
	Rate	8x 01 04 C3 01 0p 0q 0r 0s 0m 0n 0x 0y FF	pqrsmnxy: bitrate (1024~16384)
Tally Control	Off	8x 01 7E 01 0A 00 0p FF	p: 0: Off(LED off) 1: (LED green on) 2: (LED red on) 4: (LED blue on)
IP address control	IP Set	8x 01 04 AB 0p 0q 0r 0s 0m 0n 0x 0y FF	Set ip to :pq.rs.mn.xy
	Mask	8x 01 04 AC 0p 0q 0r 0s 0m 0n 0x 0y FF	Set mask to :pq.rs.mn.xy
	Gateway set	8x 01 04 AD 0p 0q 0r 0s 0m 0n 0x 0y FF	Set gateway to :pq.rs.mn.xy
Color adjust	Color Adjust OFF	8x 01 04 B6 00 FF	Color adjust off
	Color Adjust ON	8x 01 04 B6 01 FF	Color adjust on
	Brightness Balance OFF	8x 01 04 B7 00 FF	Keep Brightness
	Brightness Balance ON	8x 01 04 B7 01 FF	Don't Keep Brightness

# VISCA Protocol (CONTD)

Color adjust	Flare red	8x 01 04 B8 dat FF	Flare mode red value (Default=32)
	Flare green	8x 01 04 B9 dat FF	Flare mode green value (Default=32)
	Flare blue	8x 01 04 BA dat FF	Flare mode blue value (Default=32)
SYS_Menu	Menu On	8x 01 06 06 02 FF	Turn on menu
	Menu Off	8x 01 06 06 03 FF	Turn off menu
	Menu Back	8x 01 06 06 10 FF	Menu step back
	Menu Ok	8x 01 7E 01 02 00 01 FF	Menu ok
IR_Receive	On	8x 01 06 08 02 FF	IR(remote commander)receive ON/OFF
	Off	8x 01 06 08 03 FF	
	On/Off	8x 01 06 08 10 FF	
Cam_Tally	RGB	8x 01 7E 01 0A 00 0p FF	P=0: OFF P=1: RED P=2: GREEN P=3: RED&GREEN P=4: BLUE P=5: RED&BLUE P=6: GREEN&BLUE P=7: RED&GREEN&BLUE
Pan_TiltDrive	Up	8x 01 06 01 VV WW 03 01 FF	VV: Pan speed 0x01 (low speed) to 0x18 (high speed) WW: Tilt speed 0x01 (low speed) to 0x14 (high speed) YYYY: Pan Position(TBD) ZZZZ: Tilt Position(TBD)
	Down	8x 01 06 01 VV WW 03 02 FF	
	Left	8x 01 06 01 VV WW 01 03 FF	
	Right	8x 01 06 01 VV WW 02 03 FF	
	Upleft	8x 01 06 01 VV WW 01 01 FF	
	Upright	8x 01 06 01 VV WW 02 01 FF	
	Downleft	8x 01 06 01 VV WW 01 02 FF	
	Downright	8x 01 06 01 VV WW 02 02 FF	
	Stop	8x 01 06 01 VV WW 03 03 FF	
	Absolute Position	8x 01 06 02 VV WW 0Y 0Y 0Y 0Z 0Z 0Z FF	
	Relative Position	8x 01 06 03 VV WW 0Y 0Y 0Y 0Y 0Z 0Z 0Z FF	
	Home	8x 01 06 04 FF	
	Reset	8x 01 06 05 FF	
Pan_Tilt_LimitSet	Set	8x 01 06 07 00 0W 0Y 0Y 0Y 0Y 0Z 0Z 0Z FF	PW: 1: UpRight 0:DownLeft YYYY: Pan Limit Position(TBD) ZZZZ: Tilt Limit Position(TBD)
	Clear	8x 01 06 07 01 0W 0Y 0Y 0Y 0Y 0Z 0Z FF	

# VISCA Protocol (CONTD)

## Part 3: Inquiry Command

Command Type	Command	Return	Note
CAM_PowerInq	8x 09 04 00 FF	y0 50 02 FF	On
		y0 50 03 FF	Off (Standby)
CAM_ZoomPosInq	8x 09 04 47 FF	y0 50 0p 0q 0r 0s FF	pqrs: Zoom Position
CAM_Focus ModelInq	8x 09 04 38 FF	y0 50 02 FF	Auto Focus
		y0 50 03 FF	Manual Focus
CAM_FocusPosInq	8x 09 04 48 FF	y0 50 0p 0q 0r 0s FF	pqrs: Focus Position
CAM_WBModelInq	8x 09 04 35 FF	y0 50 00 FF	Auto
		y0 50 01 FF	Indoor Mode
		y0 50 02 FF	Outdoor Mode
		y0 50 03 FF	OnePush Mode
		y0 50 04 FF	ATW
		y0 50 05 FF	Manual
CAM_RGainInq	8x 09 04 43 FF	y0 50 00 00 0p 0q FF	pq: R Grain
CAM_BGainInq	8x 09 04 44 FF	y0 50 00 00 0p 0q FF	pq: B Grain
CAM_AEModelInq	8x 09 04 39 FF	y0 50 00 FF	Full Auto
		y0 50 03 FF	Manual
		y0 50 0A FF	Shutter Priority
		y0 50 0B FF	Iris Priority
		y0 50 0D FF	Bright
CAM_Shutter PosInq	8x 09 04 4A FF	y0 50 00 00 0p 0q FF	pq: Shutter Position
CAM_IrisPosInq	8x 09 04 4B FF	y0 50 00 00 0p 0q FF	pq: Iris Position
CAM_GainPosInq	8x 09 04 4C FF	y0 50 00 00 0p 0q FF	pq: Gain Position
CAM_BrightPosInq	8x 09 04 4D FF	y0 50 00 00 0p 0q FF	pq: Bright Position
CAM_ImageBright PosInq	8x 09 04 A4 FF	y0 50 00 00 0p 0q FF	pq: ImageBright Position
CAM_SaturationInq	8x 09 04 A1 FF	y0 50 00 00 0p 0q FF	pq: Saturation level 0x00~0x0f
CAM_DefogInq	8x 09 04 A3 FF	y0 50 0p FF	p: Defog level 0x00~0x0f
CAM_ContrastInq	8x 09 04 A2 FF	y0 50 00 00 0p 0q FF	pq: Contrast level 0x00~0x0f
CAM_WDRModelInq	8x 09 04 3D FF	y0 50 02 FF	On
		y0 50 03 FF	Off
CAM_WDRPosInq	8x 09 04 2D FF	8x 01 04 02 03 FF	pq: WDR LEVEL Position 1~6

# VISCA Protocol (CONTD)

Command Type	Command	Return	Note	
CAM_ApertureInq	8x 09 04 42 FF	y0 50 00 00 0p 0q FF	p: Aperture Gain	
CAM_FlickerInq	8x 09 04 AA FF	y0 50 0p FF	p: Flick mode 0:off 1:50Hz 2:60Hz	
CAM_2DNRInq	8x 09 04 A5 FF	y0 50 0p FF	p: 2DNR: 0=OFF 1= AUTO 2	
CAM_3DNRInq	8x 09 04 53 FF	y0 50 0p FF	p: 3DNR: 0=OFF 1= AUTO 2~5=Manual Level	
CAM_GammaInq	8x 09 04 5B FF	y0 50 0p FF	p: Gamma Position	
CAM_MemoryInq	8x 09 04 3F FF	y0 50 pp FF	pp: Memory number last operated	
SYS_MenuModelInq	8x 09 06 06 FF	y0 50 02 FF	On	
		y0 50 03 FF	Off	
CAM_LR_Reverse Inq	8x 09 04 61 FF	y0 50 02 FF	On	
		y0 50 03 FF	Off	
CAM_PictureFlipInq	8x 09 04 66 FF	y0 50 02 FF	On	
		y0 50 03 FF	Off	
CAM_IDInq	8x 09 04 22 FF	y0 50 0p 0q 0r 0s FF	pqrs: Camera ID	
CAM_DHCPInq	8x 09 04 AE FF	y0 50 pp FF		
CAM_IPInq	8x 09 04 AB FF	y0 50 0p 0p 0q 0q 0r 0r 0s 0s FF		
CAM_MASKInq	8x 09 04 AC FF	y0 50 0p 0p 0q 0q 0r 0r 0s 0s FF		
CAM_GATEWAYInq	8x 09 04 AD FF	y0 50 0p 0p 0q 0q 0r 0r 0s 0s FF		
CAM_FlareModelInq	8x 09 04 B6 FF	y0 50 pp FF		
CAM_FlareBright ModelInq	8x 09 04 B7 FF	y0 50 pp FF		
CAM_FlareRed	8x 09 04 B8 FF	y0 50 pp FF		
CAM_FlareGreen	8x 09 04 B9 FF	y0 50 pp FF		
CAM_FlareBlue	8x 09 04 BA FF	y0 50 pp FF		
CAM_VersionInq	8x 09 00 02 FF	y0 50 ab cd mn pq rs tu vw FF		
VideoSystemInq (AIDA)	8x 09 06 23 FF	y0 50 pp FF		pp: Video position
VideoSystemInq (Sony)	8x 09 04 24 72 FF	y0 50 0p 0p FF		pp: Video position
IR_Transfer	8x 09 06 1A FF	y0 50 02 FF	On	
		y0 50 03 FF	Off	
TallyInq	8x 09 7E 01 0A FF	y0 50 0p FF	p: tally state	
IR_Receive	8x 09 06 08 FF	y0 50 02 FF	On	
		y0 50 03 FF	Off	
IR_ReceiveReturn		y0 07 7D 01 04 00 FF	Power ON/OFF	

# VISCA Protocol (CONTD)

Command Type	Command	Return	Note
IR_ReceiveReturn		y0 07 7D 01 04 00 FF	Zoom tele/wide
		y0 07 7D 01 04 07 FF	AF On/Off
		y0 07 7D 01 04 33 FF	CAM_Backlight
		y0 07 7D 01 04 3F FF	CAM_Memory
		y0 07 7D 01 06 01 FF	Pan_tiltDrive
Pan-tiltMaxSpeed Inq	8x 09 06 11 FF	y0 50 ww zz FF	ww: PanMaxSpeed zz: Tilt Max Speed
Pan-tiltPosInq	8x 09 06 12 FF	y0 50 0w 0w 0w 0z 0z 0z FF	www: PanPosition zzzz: Tilt Position
Mainstream ResolutionInq	8x 09 04 C2 00 FF	y0 50 0p 0q 0r 0s 0m 0n 0x 0y FF	pqrs : Column(x size) mnx: Line (y size) only supports: 1920x1080/1280x720/1024x576
MainstreamRate Inq	8x 09 04 C2 01 FF	y0 50 0p 0q 0r 0s 0m 0n 0x 0y FF	pqrsmnx: bitrate (1024~16384)
Substream ResolutionInq	8x 09 04 C3 00 FF	y0 50 0p 0q 0r 0s 0m 0n 0x 0y FF	pqrs : Column(x size) mnx: Line (y size) only supports: 1280x720/1024x576/640x360
SubstreamRateInq	8x 09 04 C3 01 FF	y0 50 0p 0q 0r 0s 0m 0n 0x 0y FF	pqrsmnx: bitrate (1024~5120)

Note: [x] refers to camera address; [y] = [x +8]

## VISCA Pan Tilt Absolute Position Value

Pan Angle	VISCA Value	Tilt Angle	VISCA Value
-170	0xF670	-30	0xFE50
-135	0xF868	0	0x0000
-90	0xFAF0	30	0xD180
-45	0xFD78	60	0x0360
0	0x0000	90	0x510
45	0x0288		
90	0x0510		
135	0x0798		
170	0x0990		

## VISCA Pan Tilt Speed Value

Pan Degree/Second			
0	0.3	0.3	.03
1	1	1	1
2	1.5	1.5	1.5
3	2.2	2.2	2.2
4	2.4	2.4	3.6
5	2.6	2.6	4.7
6	2.8	2.8	6
7	3.0	3.0	8
8	3.2	3.2	10
9	3.4	3.4	12
10	3.8	3.8	15
11	4.5	4.5	18
12	6	6	23

Pan Degree/Second			
13	9	13	30
14	15	14	39
15	19	15	48
16	25	16	59
17	32	17	69
18	38	18	80
19	45		
20	58		
21	75		
22	88		
23	105		
24	120		

# UVC Control

AIDA PTZ's also support UVC interface.

PU_BRIGHTNESS_CONTROL	81 01 04 4d 00 00 0p 0q FF
PU_CONTRAST_CONTROL	81 01 04 A2 00 00 0p 0q FF
PU_SATURATION_CONTROL	81 01 04 A1 00 00 0p 0q FF
PU_SHARPNESS_CONTROL	8x 01 04 42 00 00 0p 0q FF
PU_GAMMA_CONTROL	8x 01 04 5B 0p FF
PU_WHITE_BALANCE_TEMPERATURE_CONTROL	8x 01 04 35 0X FF
PU_BLACKLIGHT_COMPENSATION_CONTROL	81 01 04 33 02/03 FF
PU_POWER_LINE_FREQUENCY_CONTROL	8x 01 04 AA 00/01/02 FF
CT_ZOOM_ABSOLUTE_CONTROL	8x 01 04 47 0p 0q 0r 0s FF
CT_PANTILT_ABSOLUTE_CONTROL	8x 01 06 02 VV WW 0Y 0Y 0Y 0Y OZ OZ OZ FF
CT_PANTILT_RELATIVE_CONTROL	8x 01 06 01 pp qq rr ss FF
CT_ZOOM_RELATIVE_CONTROL	8x 01 04 07 pp FF

# Warranty

## Our Promise:

AIDA Imaging warrants all its cameras and accessories to be free from defects under normal use for a period of two years after purchase date. IF proof of purchase cannot be provided during a warranty claim, AIDA Imaging reserves the right to not honor the warranty set above. Therefore, labor and parts may be charged to the consumer. For more info on our warranty, please refer to our website at:

[aidaimaging.com/warranty](http://aidaimaging.com/warranty)

## Support:

If you would like additional support or explanation on anything related to our product, please feel free to our website at [aidaimaging.com](http://aidaimaging.com) for more info!

We have Youtube tutorials located at [youtube.com/aidaimaging](http://youtube.com/aidaimaging).

## Reach out to us!:

Our contact information can be seen below:

Telephone: 909.333.7421

Email Address: [support@aidaimaging.com](mailto:support@aidaimaging.com)

We are also reachable during our normal operating business hours:

Open Yearly, Mon-Fri from 8AM to 5PM PST, excluding major holidays and events.

Also, feel free to subscribe to our newsletter which keeps you up to date on the latest and greatest firmwares we can release for your PTZ!









# AIDA

## IMAGING

1278 Center Court Dr, Covina, CA 91790

Tel: (909)-333-7421

[support@aidaimaging.com](mailto:support@aidaimaging.com)

[www.aidaimaging.com](http://www.aidaimaging.com)